

**ProLight PG1C-5LWE  
PG1C-5LxE-Rx  
5W High CRI Power LED  
Technical Datasheet  
Version: 1.4**

## Features

- High Color rendering index (CRI>70 and >80 available)
- High flux per LED
- Good color uniformity
- RoHS compliant
- Industry best moisture sensitivity level - JEDEC 2a  
4 week floor life without reconditioning
- Low-temp. & lead free reflow soldering
- More energy efficient than incandescent and most halogen lamps
- Low Voltage DC operated
- Instant light (less than 100ns)
- No UV
- Superior ESD protection

## Typical Applications

- Reading lights (car, bus, aircraft)
- Portable (flashlight, bicycle)
- Uplighters/Downlighters
- Decorative/Entertainment
- Bollards/Security/Garden
- Cove/Undershelf/Task
- Indoor/Outdoor Commercial and Residential Architectural
- Automotive Ext (Stop-Tail-Turn, CHMSL, Mirror Side Repeat)
- LCD backlights

# Emitter Mechanical Dimensions

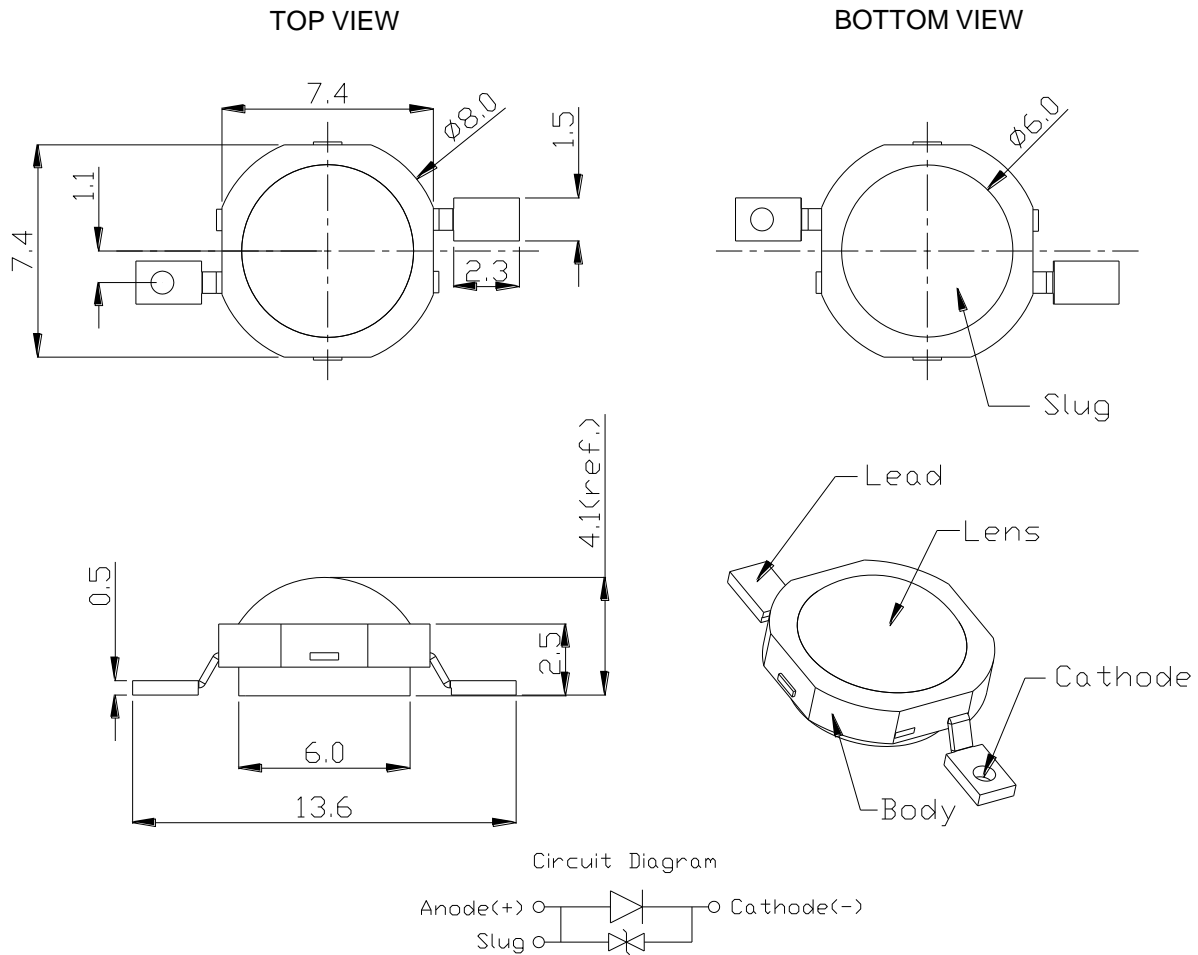

**Notes:**

1. The Anode side of the device is denoted by a hole in the lead frame.
2. Electrical insulation between the case and the board is required --- slug of device is not electrically neutral. Do not electrically connect either the anode or cathode to the slug.
3. Drawing not to scale.
4. All dimensions are in millimeters.
5. All dimensions without tolerances are for reference only.
6. Please do not bend the leads of the LED, otherwise it will damage the LED.
7. **Please do not use a force of over 3kgf impact or pressure on the lens of the LED, otherwise it will cause a catastrophic failure.**

\*The appearance and specifications of the product may be modified for improvement without notice.

## Flux Characteristics at 700mA, T<sub>J</sub> = 25°C

Radiation Pattern	Color	Part Number Emitter	Lumious Flux $\Phi_v$ (lm)		CRI Typical
			Minimum	Typical	
Lambertian	White	PG1C-5LWE	324.5	350	75
	Warm White	PG1C-5LVE-R7	249.6	280	75
	White	PG1C-5LWE-R8	249.6	295	83
	Warm White	PG1C-5LVE-R8	192	220	83

- ProLight maintains a tolerance of  $\pm 10\%$  on flux and power measurements.
- Please do not drive at rated current more than 1 second without proper heat sink.

## Electrical Characteristics at 700mA, T<sub>J</sub> = 25°C

Color	Forward Voltage V <sub>F</sub> (V)			Thermal Resistance Junction to Slug (°C/ W)
	Min.	Typ.	Max.	
White	5.7	7.0	8.2	6
Warm White	5.7	7.0	8.2	6

## Optical Characteristics at 700mA, T<sub>J</sub> = 25°C

Color	Dominant Wavelength $\lambda_D$ , or Color Temperature CCT			Total included Angle (degrees) $\theta_{0.90V}$	Viewing Angle (degrees) $2 \theta_{1/2}$
	Min.	Typ.	Max.		
White	4100 K	5500 K	10000 K	160	140
Warm White	2700 K	3300 K	4100 K	160	140

- ProLight maintains a tolerance of  $\pm 1\text{nm}$  for dominant wavelength measurements.
- ProLight maintains a tolerance of  $\pm 5\%$  for CCT measurements.

## Absolute Maximum Ratings

Parameter	White/Warm White
DC Forward Current (mA)	700
Peak Pulsed Forward Current (mA)	1000
Average Forward Current (mA)	700
ESD Sensitivity (HBM per MIL-STD-883E Method 3015.7)	±4000V (Class III)
LED Junction Temperature (°C)	120
Aluminum-core PCB Temperature (°C)	105
Storage & Operating Temperature (°C)	-40 to + 105
Soldering Temperature(°C)	235°C

## Photometric Luminous Flux Bin Structure

Part Number	Bin Code	Minimum Photometric Flux (lm)	Maximum Photometric Flux (lm)	Available Color Bins
PG1C-5LWE	Z1	324.5	369.9	All
	Z2	369.9	421.9	Xx, Wx <sup>[1]</sup>
PG1C-5LVE-R7	Y1	249.6	284.5	All
	Y2	284.5	324.5	[1]
PG1C-5LWE-R8	Y1	249.6	284.5	All
	Y2	284.5	324.5	Xx, Wx <sup>[1]</sup>
PG1C-5LVE-R8	X1	192	218.9	All
	X2	218.9	249.6	[1]

- ProLight maintains a tolerance of ± 10% on flux and power measurements.
- The flux bin of the product may be modified for improvement without notice.
- <sup>[1]</sup> The rest of color bins are not 100% ready for order currently. Please ask for quote and order possibility.

# Color Bin

## White and Warm White Binning Structure Graphical Representation

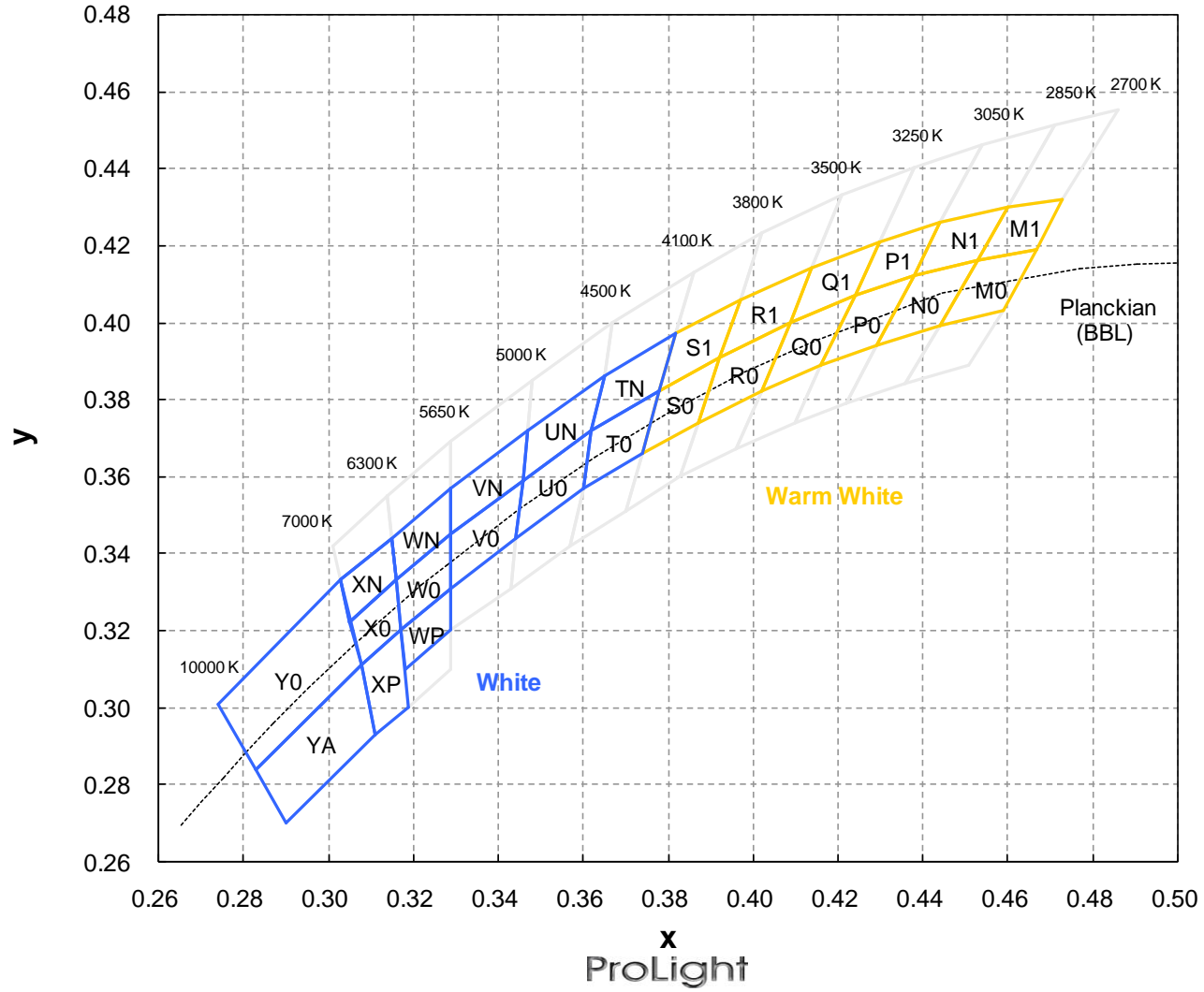

## Color Bins

### White Bin Structure

Bin Code	x	y	Typ. CCT (K)	Bin Code	x	y	Typ. CCT (K)
T0	0.378	0.382	4300	WN	0.329	0.345	5970
	0.374	0.366			0.316	0.333	
	0.360	0.357			0.315	0.344	
	0.362	0.372			0.329	0.357	
TN	0.382	0.397	4300	WP	0.329	0.331	5970
	0.378	0.382			0.329	0.320	
	0.362	0.372			0.318	0.310	
	0.365	0.386			0.317	0.320	
U0	0.362	0.372	4750	X0	0.308	0.311	6650
	0.360	0.357			0.305	0.322	
	0.344	0.344			0.316	0.333	
	0.346	0.359			0.317	0.320	
UN	0.365	0.386	4750	XN	0.305	0.322	6650
	0.362	0.372			0.303	0.333	
	0.346	0.359			0.315	0.344	
	0.347	0.372			0.316	0.333	
V0	0.329	0.331	5320	XP	0.308	0.311	6650
	0.329	0.345			0.317	0.320	
	0.346	0.359			0.319	0.300	
	0.344	0.344			0.311	0.293	
VN	0.329	0.345	5320	Y0	0.308	0.311	8000
	0.329	0.357			0.283	0.284	
	0.347	0.372			0.274	0.301	
	0.346	0.359			0.303	0.333	
W0	0.329	0.345	5970	YA	0.308	0.311	8000
	0.329	0.331			0.311	0.293	
	0.317	0.320			0.290	0.270	
	0.316	0.333			0.283	0.284	

- Tolerance on each color bin (x , y) is  $\pm 0.01$

Note: Although several bins are outlined, product availability in a particular bin varies by production run and by product performance. Not all bins are available in all colors.

## Color Bins

### Warm White Bin Structure

Bin Code	x	y	Typ. CCT (K)	Bin Code	x	y	Typ. CCT (K)
M0	0.453	0.416	2770	Q0	0.409	0.400	3370
	0.444	0.399			0.402	0.382	
	0.459	0.403			0.416	0.389	
	0.467	0.419			0.424	0.407	
M1	0.460	0.430	2770	Q1	0.414	0.414	3370
	0.453	0.416			0.409	0.400	
	0.467	0.419			0.424	0.407	
	0.473	0.432			0.430	0.421	
N0	0.438	0.412	2950	R0	0.392	0.391	3650
	0.429	0.394			0.387	0.374	
	0.444	0.399			0.402	0.382	
	0.453	0.416			0.409	0.400	
N1	0.444	0.426	2950	R1	0.414	0.414	3650
	0.438	0.412			0.409	0.400	
	0.453	0.416			0.392	0.391	
	0.460	0.430			0.397	0.406	
P0	0.424	0.407	3150	S0	0.392	0.391	3950
	0.416	0.389			0.387	0.374	
	0.429	0.394			0.374	0.366	
	0.438	0.412			0.378	0.382	
P1	0.430	0.421	3150	S1	0.397	0.406	3950
	0.424	0.407			0.392	0.391	
	0.438	0.412			0.378	0.382	
	0.444	0.426			0.382	0.397	

- Tolerance on each color bin (x , y) is  $\pm 0.01$

Note: Although several bins are outlined, product availability in a particular bin varies by production run and by product performance. Not all bins are available in all colors.

# Color Spectrum, $T_J = 25^\circ\text{C}$

## 1. White

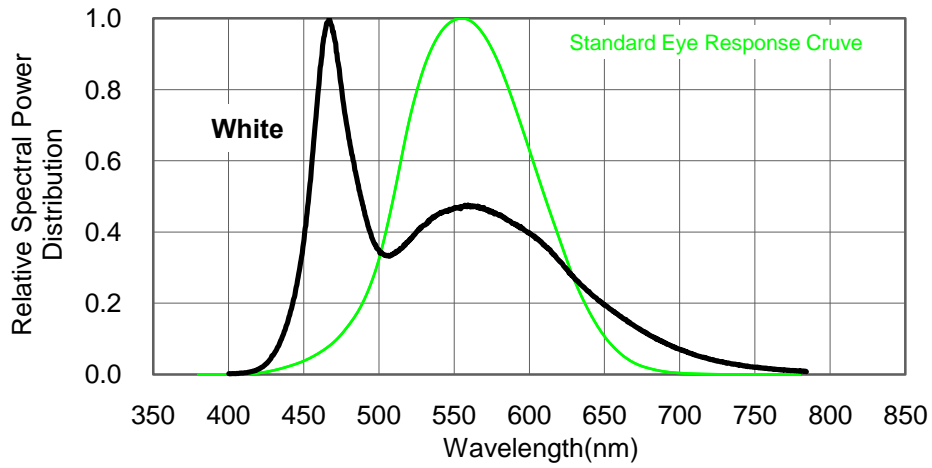

## 2. Warm White For R7

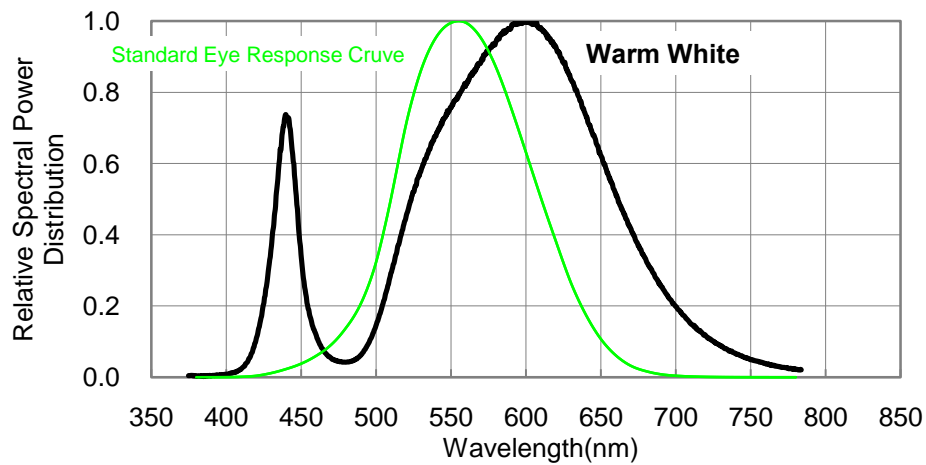

## 3. White 、 Warm White For R8

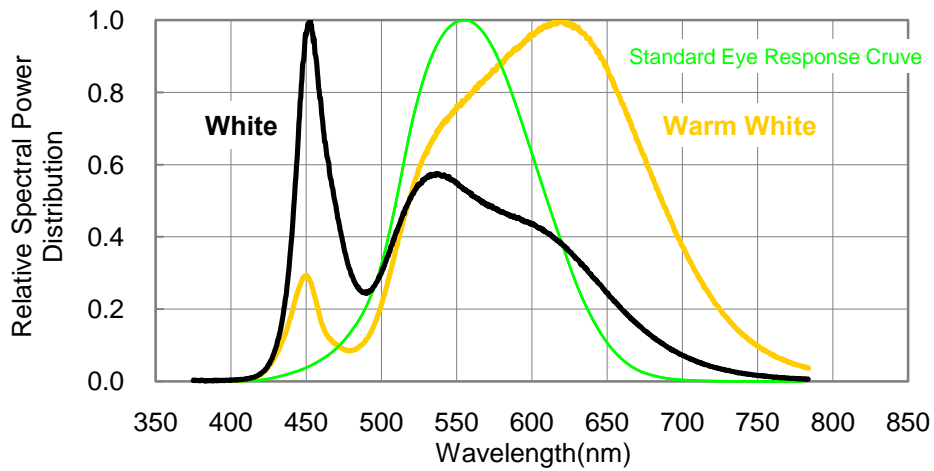

ProLight

# Light Output Characteristics

## Relative Light Output vs. Junction Temperature at 700mA

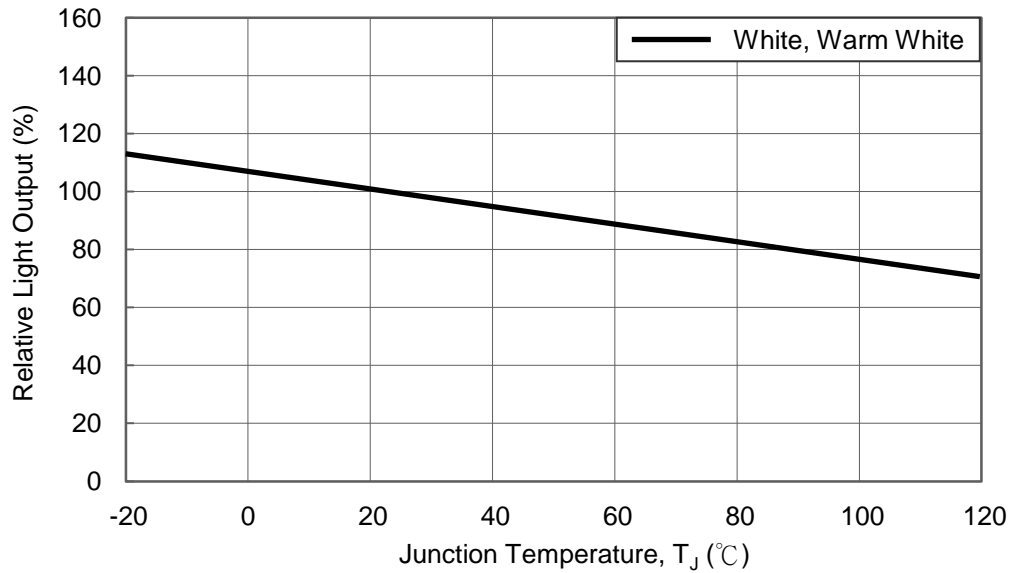

## Forward Current Characteristics, $T_j = 25^\circ\text{C}$

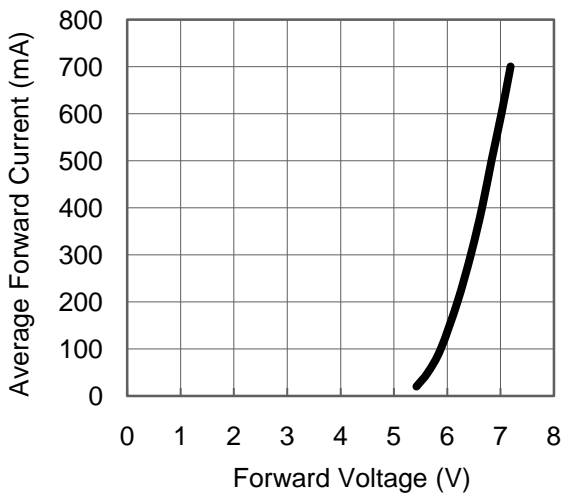

Fig 1. Forward Current vs. Forward Voltage for White, Warm White.

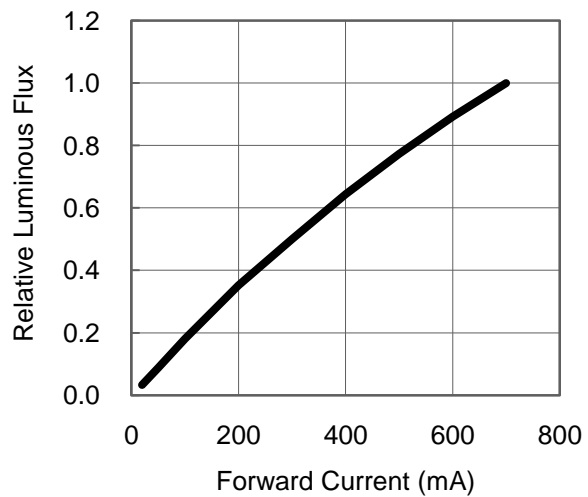
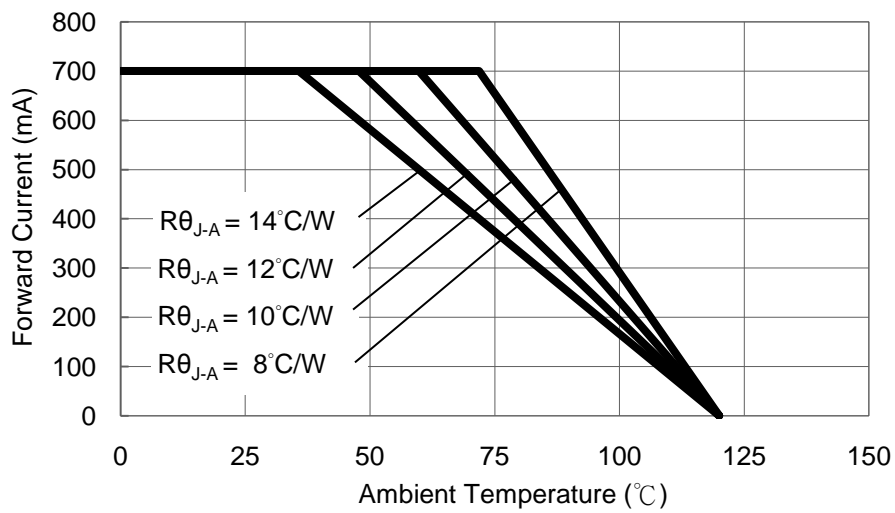

Fig 2. Relative Luminous Flux vs. Forward Current for White, Warm White at  $T_j=25^\circ\text{C}$  maintained.

# Ambient Temperature vs. Maximum Forward Current

## 1. White, Warm White ( $T_{JMAX} = 120^{\circ}C$ )



# Typical Representative Spatial Radiation Pattern

## Lambertian Radiation Pattern

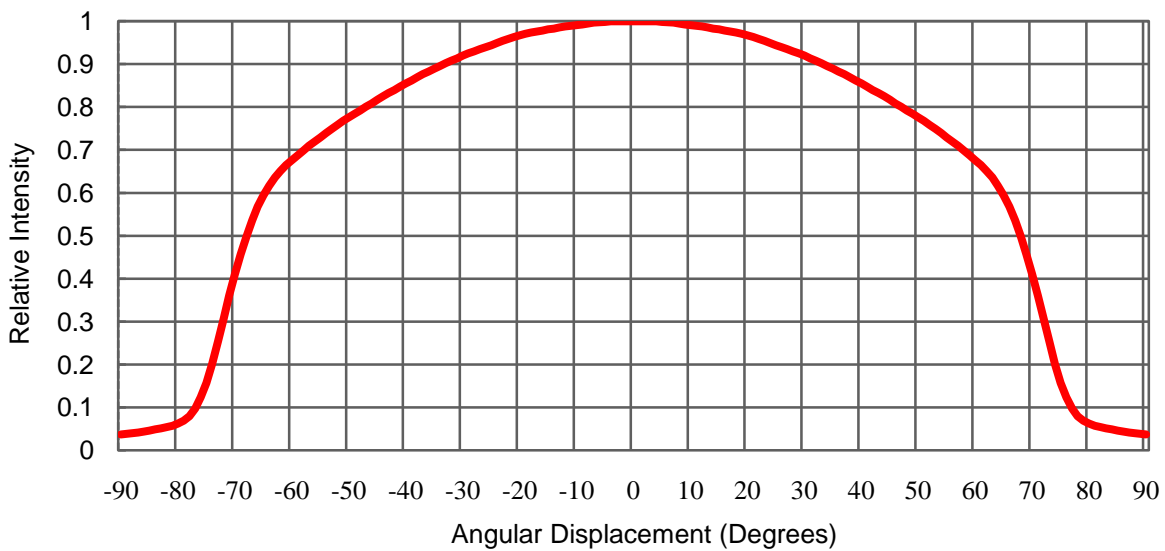

## Moisture Sensitivity Level - JEDEC 2a

Level	Floor Life		Soak Requirements			
			Standard		Accelerated Environment	
	Time	Conditions	Time (hours)	Conditions	Time (hours)	Conditions
2a	4 weeks	≤30°C / 60% RH	696 +5/-0	30°C / 60% RH	120 +1/-0	60°C / 60% RH

- The standard soak time includes a default value of 24 hours for semiconductor manufacture's exposure time (MET) between bake and bag and includes the maximum time allowed out of the bag at the distributor's facility.
- Table below presents the moisture sensitivity level definitions per IPC/JEDEC's J-STD-020C.

Level	Floor Life		Soak Requirements			
			Standard		Accelerated Environment	
	Time	Conditions	Time (hours)	Conditions	Time (hours)	Conditions
1	Unlimited	≤30°C / 85% RH	168 +5/-0	85°C / 85% RH	NA	NA
2	1 year	≤30°C / 60% RH	168 +5/-0	85°C / 60% RH	NA	NA
2a	4 weeks	≤30°C / 60% RH	696 +5/-0	30°C / 60% RH	120 +1/-0	60°C / 60% RH
3	168 hours	≤30°C / 60% RH	192 +5/-0	30°C / 60% RH	40 +1/-0	60°C / 60% RH
4	72 hours	≤30°C / 60% RH	96 +2/-0	30°C / 60% RH	20 +0.5/-0	60°C / 60% RH
5	48 hours	≤30°C / 60% RH	72 +2/-0	30°C / 60% RH	15 +0.5/-0	60°C / 60% RH
5a	24 hours	≤30°C / 60% RH	48 +2/-0	30°C / 60% RH	10 +0.5/-0	60°C / 60% RH
6	Time on Label (TOL)	≤30°C / 60% RH	Time on Label (TOL)	30°C / 60% RH	NA	NA

## Qualification Reliability Testing

Stress Test	Stress Conditions	Stress Duration	Failure Criteria
Room Temperature Operating Life (RTOL)	25°C, $I_F = \text{max DC}$ (Note 1)	1000 hours	Note 2
Wet High Temperature Operating Life (WHTOL)	85°C/60%RH, $I_F = \text{max DC}$ (Note 1)	1000 hours	Note 2
Wet High Temperature Storage Life (WHTSL)	85°C/85%RH, non-operating	1000 hours	Note 2
High Temperature Storage Life (HTSL)	110°C, non-operating	1000 hours	Note 2
Low Temperature Storage Life (LTSL)	-40°C, non-operating	1000 hours	Note 2
Non-operating Temperature Cycle (TMCL)	-40°C to 120°C, 30 min. dwell, <5 min. transfer	200 cycles	Note 2
Non-operating Thermal Shock (TMSK)	-40°C to 120°C, 20 min. dwell, <20 sec. transfer	200 cycles	Note 2
Mechanical Shock	1500 G, 0.5 msec. pulse, 5 shocks each 6 axis		Note 3
Natural Drop	On concrete from 1.2 m, 3X		Note 3
Variable Vibration Frequency	10-2000-10 Hz, log or linear sweep rate, 20 G about 1 min., 1.5 mm, 3X/axis		Note 3
Solder Heat Resistance (SHR)	260°C ± 5°C, 10 sec.		Note 3
Solderability	Steam age for 16 hrs., then solder dip at 260°C for 5 sec.		Solder coverage on lead

### Notes:

1. Depending on the maximum derating curve.
2. Criteria for judging failure

Item	Test Condition	Criteria for Judgement	
		Min.	Max.
Forward Voltage ( $V_F$ )	$I_F = \text{max DC}$	--	Initial Level x 1.1
Luminous Flux or Radiometric Power ( $\Phi_V$ )	$I_F = \text{max DC}$	Initial Level x 0.7	--
Reverse Current ( $I_R$ )	$V_R = 5V$	--	50 $\mu A$

\* The test is performed after the LED is cooled down to the room temperature.

3. A failure is an LED that is open or shorted.

## Recommended Solder Pad Design

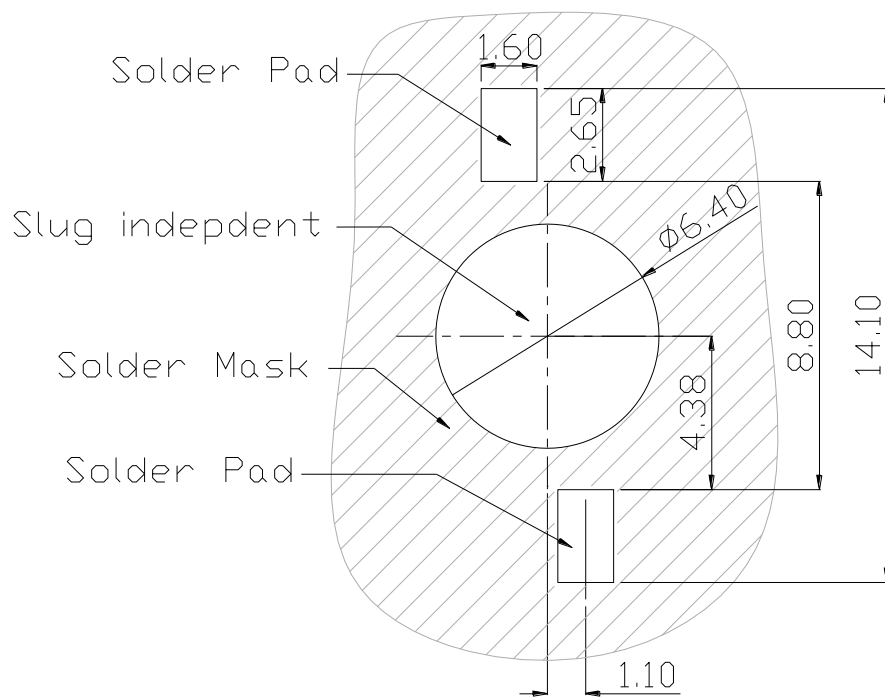

- All dimensions are in millimeters.
- Electrical isolation is required between Slug and Solder Pad.

## Reflow Soldering Condition

Profile Feature	Sn-Pb Eutectic Assembly	Low-Temp. & Pb-Free Assembly (58Bi-42Sn Eutectic Alloy)
<b>Preheat &amp; Soak</b>		
Temperature min ( $T_{smin}$ )	100 °C	90 °C
Temperature max ( $T_{smax}$ )	150 °C	120 °C
Time ( $T_{smin}$ to $T_{smax}$ )	60-120 seconds	60-120 seconds
Average Ramp-Up Rate ( $T_{smax}$ to $T_P$ )	3 °C / second max.	2 °C / second max.
Liquidous temperature ( $T_L$ )	183°C	138°C
Time at liquidous ( $t_L$ )	60-150 seconds	20-50 seconds
Peak package body temperature ( $T_P$ )	235°C	185°C
Time ( $t_p$ ) within 5°C of the specified classification temperature ( $T_C$ )	20 seconds	20 seconds
Average ramp-down rate ( $T_P$ to $T_{smax}$ )	6 °C/second max.	3 °C/second max.
Time 25°C to Peak Temperature	6 minutes max.	4 minutes max.

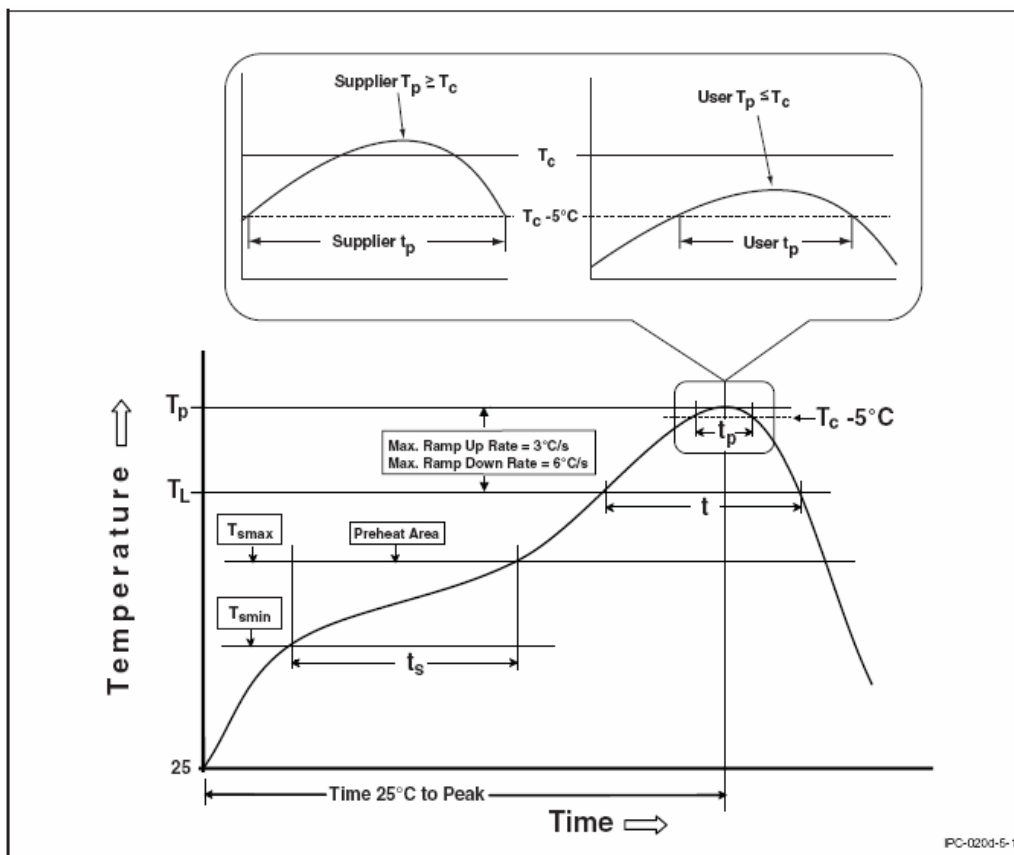

- All temperatures refer to topside of the package, measured on the package body surface.
- Repairing should not be done after the LEDs have been soldered. When repairing is unavoidable, a heat plate should be used. It should be confirmed beforehand whether the characteristics of LEDs will or will not be damaged by repairing.
- Reflow soldering should not be done more than two times.
- When soldering, do not put stress on the LEDs during heating.
- After soldering, do not warp the circuit board.

## Heat Plate Soldering Condition

### (1) Soldering Process for Solder Paste

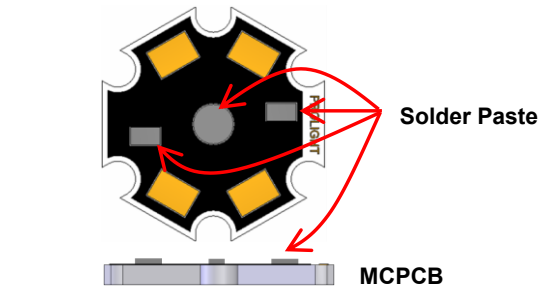

Use Solder Mask to print Solder Paste on MCPCB.

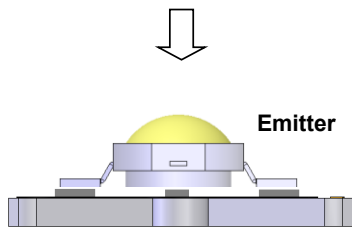

Place Emitter on MCPCB.

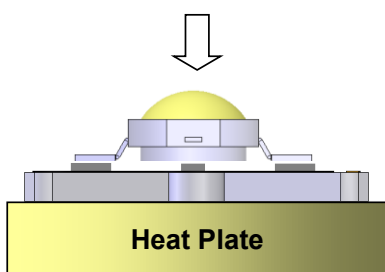

Put MCPCB on Heat Plate until Solder Paste melt.  
The Solder Paste could be melted within 10 seconds.  
Take out MCPCB out from Heat Plate within 15 seconds.

### (2) Soldering Process for Solder Wire

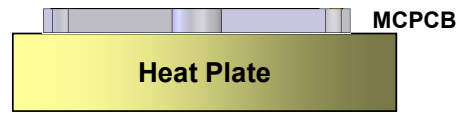

Put MCPCB on Heat Plate.

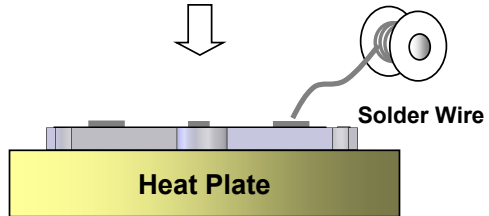

Place Solder Wire to the solder pad of MCPCB.

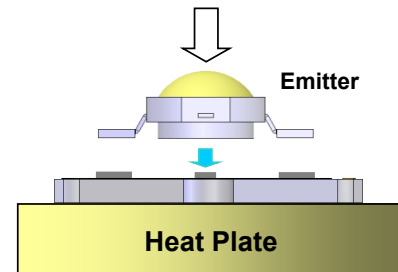

Put Emitter on MCPCB. Take the MCPCB out from Heat Plate within 10 seconds.

- Heat plate temperature: 230°C max for Lead Solder and 230°C max for Lead-Free Solder.
- We recommend using the 58Bi-42Sn eutectic alloy for low-temp. and lead free soldering (melting point = 138 °C).
- When soldering, do not put stress on the LEDs during heating.
- After soldering, do not warp the circuit board.

## Manual Hand Soldering

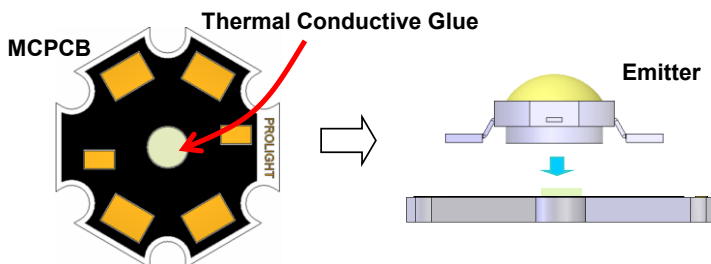

Place Thermal Comductive Glue on the MCPCB.

Place Emitter on the MCPCB.

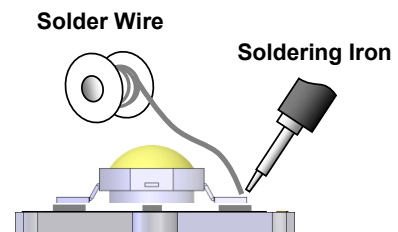

Use Soldering Iron to solder the leads of Emitter within 5 seconds.

- For prototype builds or small series production runs it possible to place and solder the emitters by hand.
- Solder tip temperature: 230°C max for Lead Solder and 260°C max for Lead-Free Solder.
- Avoiding damage to the emitter or to the MCPCB dielectric layer. Damage to the epoxy layer can cause a short circuit in the array.
- Do not let the solder contact from solder pad to back-side of MCPCB. This one will cause a short circuit and damage emitter.

## Emitter Tube Packaging

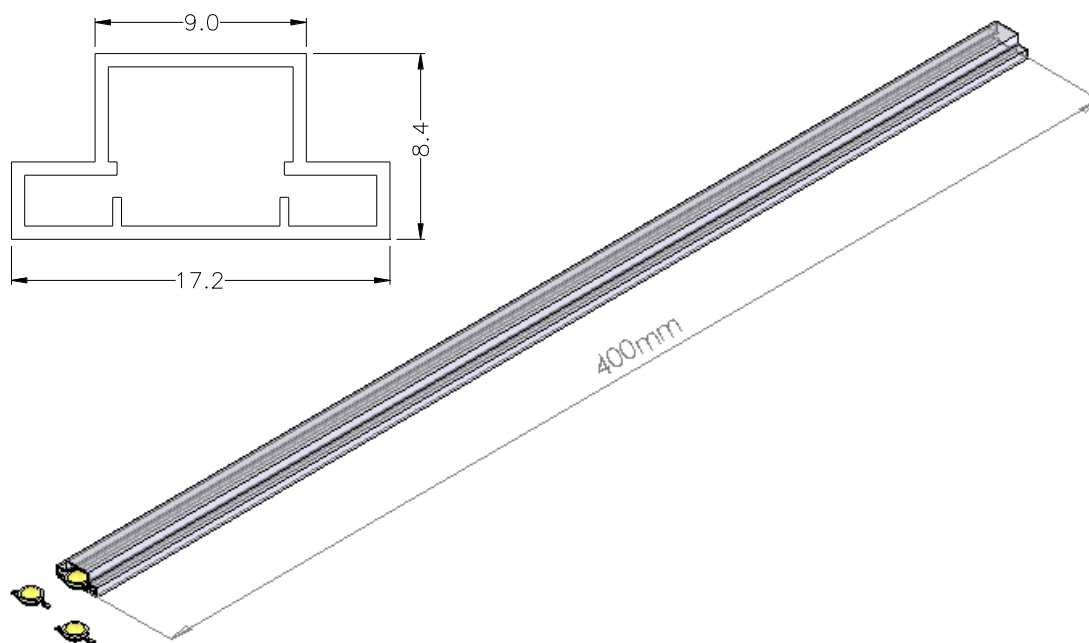

### Notes:

1. 50 pieces per tube.
2. Drawing not to scale.
3. All dimensions are in millimeters.
4. All dimensions without tolerances are for reference only.

\*\*Please do not open the moisture barrier bag (MBB) more than one week. This may cause the leads of LED discoloration. We recommend storing ProLight's LEDs in a dry box after opening the MBB. The recommended storage conditions are temperature 5 to 30°C and humidity less than 40% RH.

## Precaution for Use

- Storage  
Please do not open the moisture barrier bag (MBB) more than one week. This may cause the leads of LED discoloration. We recommend storing ProLight's LEDs in a dry box after opening the MBB. The recommended storage conditions are temperature 5 to 30°C and humidity less than 40% RH. It is also recommended to return the LEDs to the MBB and to reseal the MBB.
- The slug is not electrically neutral. Therefore, we recommend to isolate the heat sink.
- The slug is to be soldered. If not, please use the heat conductive adhesive.
- Any mechanical force or any excess vibration shall not be accepted to apply during cooling process to normal temperature after soldering.
- Please avoid rapid cooling after soldering.
- Components should not be mounted on warped direction of PCB.
- Repairing should not be done after the LEDs have been soldered. When repairing is unavoidable, a heat plate should be used. It should be confirmed beforehand whether the characteristics of the LEDs will or will not be damaged by repairing.
- This device should not be used in any type of fluid such as water, oil, organic solvent and etc. When cleaning is required, isopropyl alcohol should be used.
- When the LEDs are illuminating, operating current should be decided after considering the package maximum temperature.
- The appearance, specifications and flux bin of the product may be modified for improvement without notice. Please refer to the below website for the latest datasheets.  
<http://www.prolightopto.com/>

## Handling of Silicone Lens LEDs

Notes for handling of silicone lens LEDs

- Please do not use a force of over 3kgf impact or pressure on the silicone lens, otherwise it will cause a catastrophic failure.
- The LEDs should only be picked up by making contact with the sides of the LED body.
- Avoid touching the silicone lens especially by sharp tools such as Tweezers.
- Avoid leaving fingerprints on the silicone lens.
- Please store the LEDs away from dusty areas or seal the product against dust.
- When populating boards in SMT production, there are basically no restrictions regarding the form of the pick and place nozzle, except that mechanical pressure on the silicone lens must be prevented.
- Please do not mold over the silicone lens with another resin. (epoxy, urethane, etc)

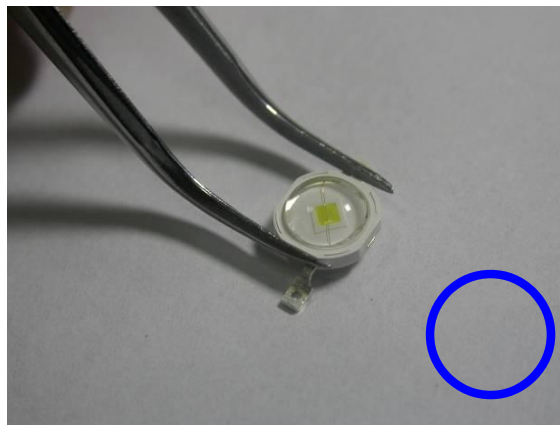
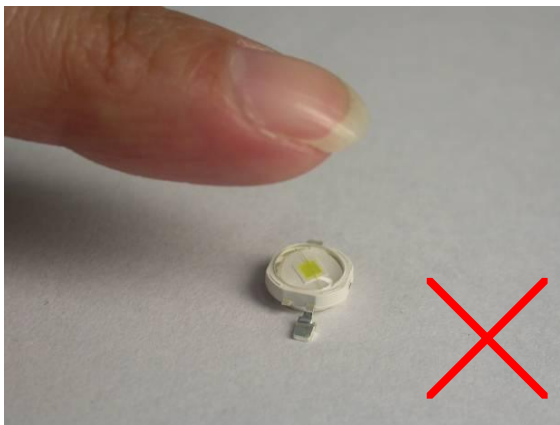

ProLight